

UNIPRESS

ATT AUTOMATIC TENSIONING TOPPER



- *Automatic Measuring*
- *Stainless Steel Pleat Pads*
- *High Capacity Blower*
- *Minimum Floor Space*
- *Easy To Operate*
- *Elastic Waist Extension*

ATT TECHNICAL DATA

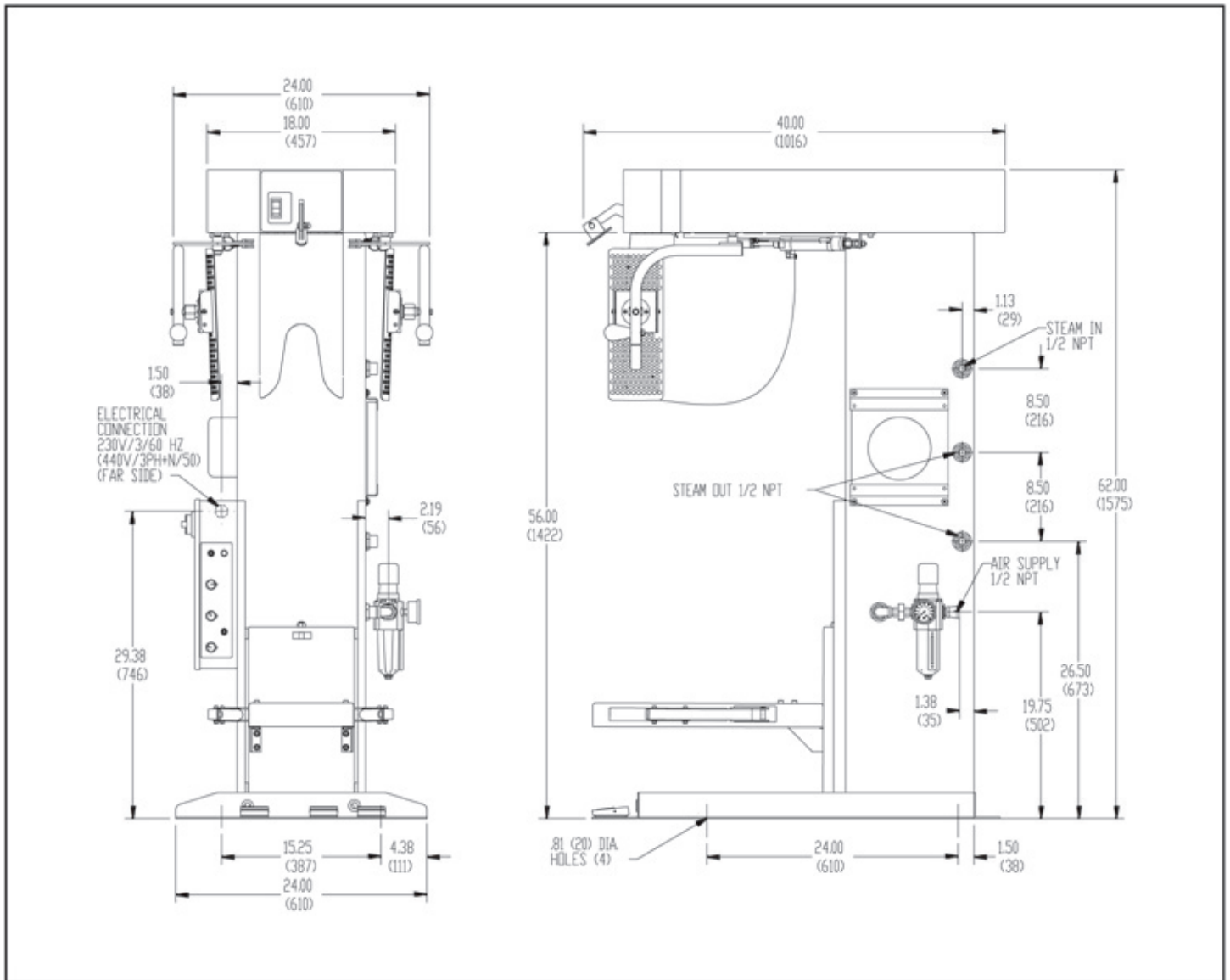

SPECIFICATIONS

TYPE	ATT
Overall Height	62"
Overall Length	40"
Overall Width	24"
Steam Inlet (1)	1/2" NPT
Steam Outlet (2)	1/2" NPT
Steam Supply	85 PSI
Boiler Horsepower	3/4 BHP
Air Supply	85 PSI
Air Consumption	0.1 CU FT
Electrical	230/3/60
Amperage	2 Amps
Net Weight	275 lbs.



Unipress reserves the right to alter or vary the specifications contained in this leaflet without notice. Drawings not to scale.

UNIPRESS

3501 Queen Palm Drive Tampa, Florida 33619
 Telephone (813) 623-3731 FAX (813) 626-2565
www.unipresscorp.com